



Solutions for

# HOME RENOVATION

9 suggestions for

**improving the practicality and aesthetics**

of your living space

## Why gypsum in interiors improves the quality of the indoor life



Gypsum is an environmentally friendly material, completely harmless to humans. In conditions of increased humidity, it absorbs moisture. When the relative humidity of the air drops, it releases the accumulated moisture. Thus gypsum is an excellent regulator of indoor humidity.

Another great feature of gypsum is its exceptional resistance to high temperatures. Gypsum contains a high percentage of water, which in the case of a 15 mm plasterboard is several liters per m<sup>2</sup>. In case of fire, this water acts as a self-extinguishing agent. Therefore, this material is considered fire-proof and is used as a component in a protective systems for various non-fire-resistant elements, such as wood or steel construction.

Plaster based surface is warm and pleasant to the touch. Its pH value corresponds to the pH value of human skin. It has no smell. It is not susceptible to electricity and has extremely low natural radioactivity. Gypsum contributes to a healthy microclimate of the room. It is characterized by excellent thermal and sound insulation properties.

It's **environmental-friendly** and created a **healthy indoor** environment

- It has increased **permeability to water diffusion**, ensuring that the wall and ceilings breathe
- It is hydroscopic - it **regulates the microclimate** of the rooms.
- It is a warm material with **thermo-insulating** properties, ensuring interior comfort
- It is **non-combustible**



## DIY interior renovation

# Opportunity to practice personal creativity and skills

Renovation and adaptation are a process that visually changes the look of the interior. Home-owners resort to this process intending to refresh their premises with a new look, ie adapting them to their wishes and needs. Although the renovation involves a whole series of additional works, you do not have to hire specialized agencies for each of them. With a little creativity, time, and goodwill, you can do some things yourself.

Plasterboard systems are playing an increasing role in the adaptation and construction of residential and commercial buildings. Unlike the old building models, these building systems are very flexible and allow multiple applications. There are almost no restrictions in the application of plasterboards, with **SINIAT**, so you can create any interior you can imagine. Yet not only that but also to give the existing space a better quality of the living. The great possibility of combining the shapes and types of gypsum elements ensures that all the wishes and ideas of the investor or architect are realized.

### The content

With this brochure we want to share with you **some ideas about the reconstruction of your apartments and houses** based on our experience. On the following pages you can find arguments why it is good to apply this in your living space. If you need any additional advice, you can always contact us via our website: [www.siniat.ro](http://www.siniat.ro)



# How to insulate a living space from the NOISE coming from the neighborhoods



Noise is any unwanted sound that reaches us. This means that your children's playful scream makes less noise for you than for your neighbor. Listening to your favorite composition, intensified, is a pleasure for you but insomnia for neighbors. In addition, noise is more noticeable at night when the no. of sound sources in the building is smaller. As we can see, noise is actually a very complicated phenomenon that directly affects the quality of our lives and is increasingly becoming a source of a special kind of stress that is slowly damaging health.

Our apartments are usually exposed to two sources of the noise:

- **Internal** - those that are coming from the building itself (installations-plumbing, elevators, neighbor voices, TV&stereo sets, appliances ...)
- **External** - everything coming from the street

Determining the proper source of disturbing noise is a first step in taming



Why are some apartemens exposed to the neighborhood?

- Lack of insulation materials - old age buildings
- Bad quality of works - new age buildings
- Bad quality of material/bad choice of insulating material

The most common points of sound transmission:

- Partition walls
- Floors (floor joists)
- Windows and doors of bad quality
- Access panels with no sound insulation property

- If the daily noise level is constantly higher than 35 dB, than your health might be endangered.
- If the night noise is higher than 35 dB, than there is no doubt about it.

## Solutions

Solutions Plasterboards are an ideal solution for increasing the noise-insulating property of an single position in the apartment, such as a wall or ceiling. Materials are easy to obtain, light for transport even if the apartment is located on a high floor. Upgrades will take a minimal amount of a floor surface or the height of the room.

### How to insulate the wall



Noise insulation improvement of the 250 mm ceramic block based partition wall.

### How to insulate the ceiling

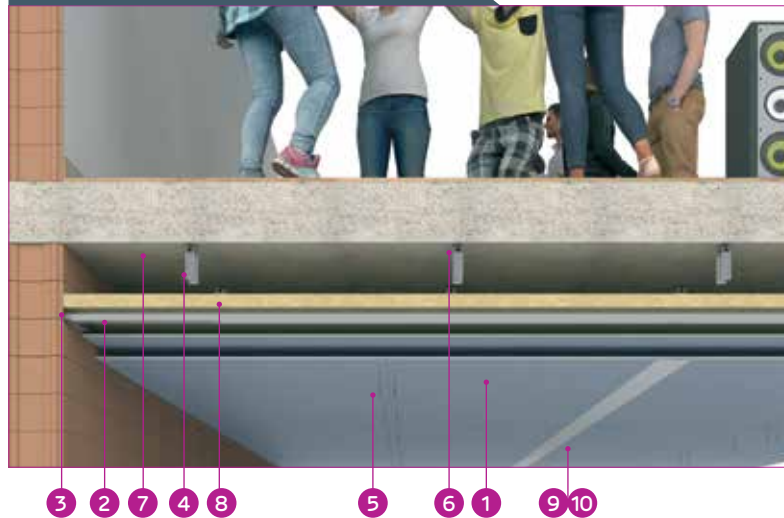

Noise insulation improvement of the 150 mm concrete based floor.

$R_w$  48 dB











$\Delta$  67 dB

$R_w$  54 dB

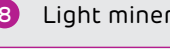

$\Delta$  73 dB

## Components

- 1  Plasterboards of the higher density, such as: **NIDA Acoustic 12.5 mm** or **LaDura 12.5 mm**
- 2  Nida Metal profiles **CD and UD**
- 3  Insulation tape
- 4  Acoustic bracket **9-12**
- 5  **Fixings Nida Metal AF screws**
- 6  Metal dowels **6x40**
- 7  **FlatHead screw**
- 8  Light mineral wool (10-15kg/m<sup>3</sup>)
- 9  Jointing compound **NIDA Professional**
- 10  Jointing tape **Connect**

\* $\Delta$  represent a difference in the sound insulation rate between the old and upgraded position.

> For the assembling instructions please consult the «Ghid de montaj» brochure that you can find on: [www.siniat.ro](http://www.siniat.ro)



## How to assemble a decorative SCAFELE in the upper corners of rooms



Ambiances can be significantly improved both in terms of visual and comfort by the proper combination of well-designed plasterboard-based suspended multi-layers elements. This application can be used to accentuate a particular segment of the room or for complete interior aesthetic change. Such an effect is achieved on suspended elements by lighting features that are attached to them. Lighting can be discrete, indirect, focused, or dispersed, it can adapt the function of the room, communication, and movements of inhabitants. Practical side of this application must not be ignored because in the corners of the rooms or on the ceiling surface there are always various installations that should be hidden for aesthetic reasons.

### Version 1

If the ceiling has no touching points with the wall, but is left a narrow channel for installing hidden corner light.

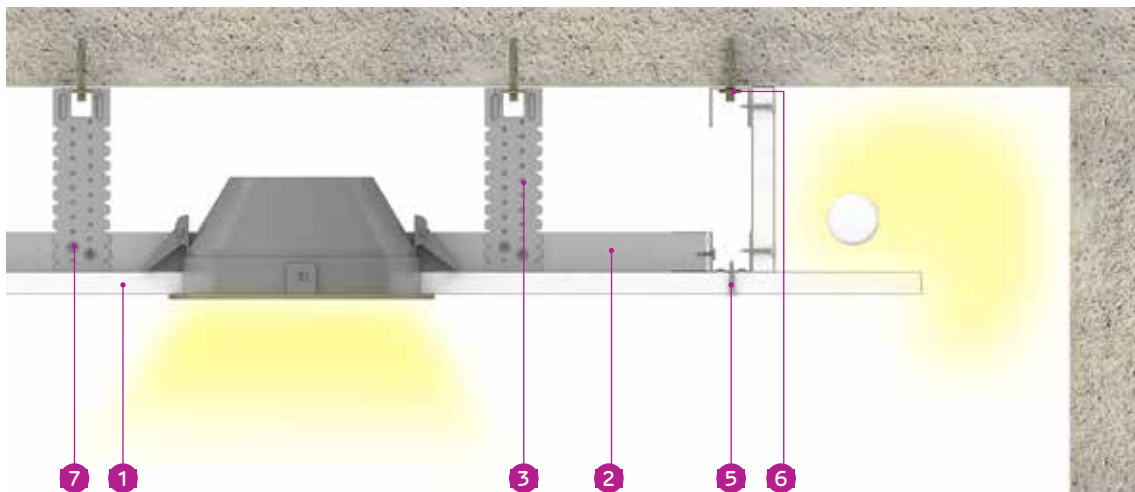

### Are your walls and ceiling appropriate for the cove light?

The flatness of the wall surface looks perfect until the moment of exposure to a strong or concentrated source of illumination, which is a cove light. In practice, wavy irregularities sometimes appear together with the remains of insufficiently filled nail holes.

Therefore, it is very important to pre-test the wall with strong artificial light in order to detect surface defects that need to be removed.

## Version 2

Two independent plasterboard applications with the direct light installed on the horizontal surface of the upper segment and the hidden light integrated into the lower segment.

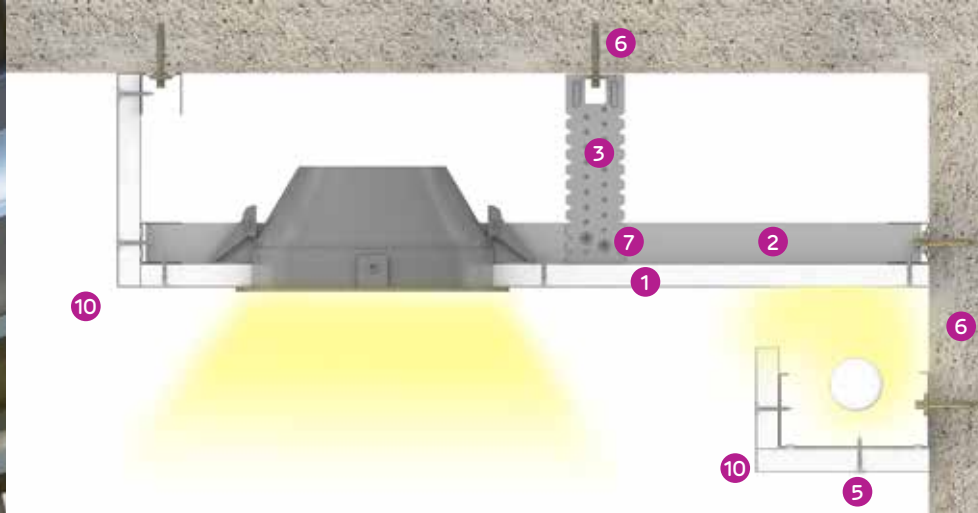





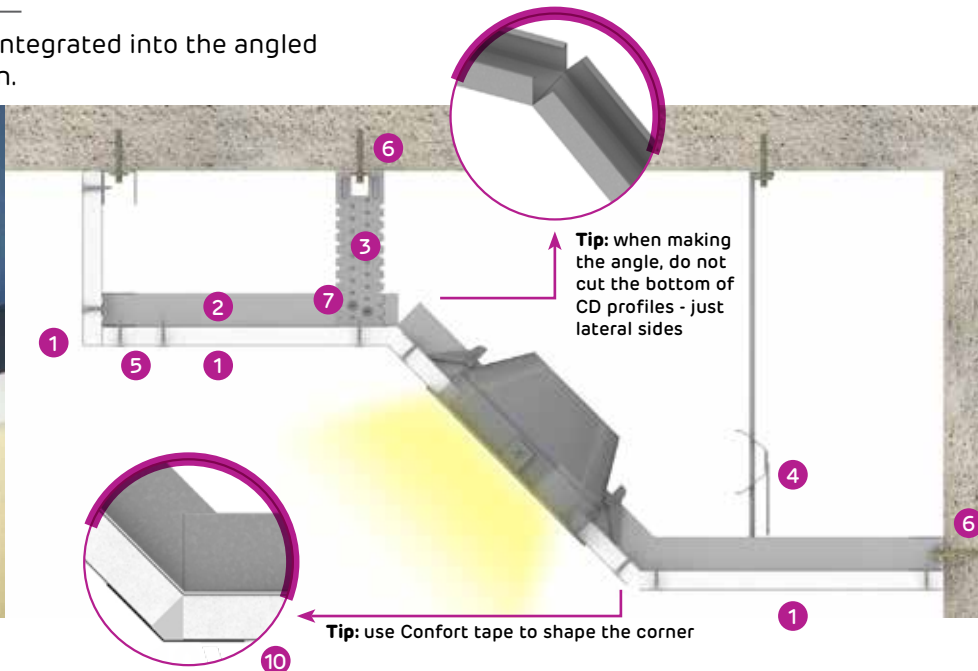

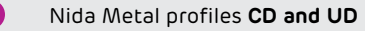

## Version 3

Single level element with the direct light integrated into the angled side of the plasterboard corner application.



## Components

- 1  Plasterboards of the higher density, such as:  
**NIDA Acoustic 12.5 mm**  
**LaDura 12.5 mm**  
**NIDA Flam 12.5 mm**
- 2  Nida Metal profiles **CD and UD**
- 3  Multiple bracket **9-12**
- 4  Suspension bracket **CD60**
- 5  Fixings Nida Metal **AF screws**
- 6  Metal dowels **6x40**
- 7  **Flat Head screw**
- 8  Jointing compound **NIDA Profesional**
- 9  Jointing tape **Connect**
- 10  Corner protection tape **Comfort**

## How to integrate a LOGGIA into a room



Integrating the loggia into a room is the easiest way for expanding an appartement! Balconies enclosed on both sides are ideal for creating additional space, whether it is an extension of the room next to it, or the creation of a completely new, separate content. Loggias are usually very narrow but can still be valuable. Often an extra 3 square meters come in very handy in creating a more functional living space. Extending the living room, additional wardrobe space, small office or reading corner, dining area... ideas are numerous!

First step in this process should be closing the open space toward the outside with big glass surfaces. Right after comes coating of rough ceramic and concrete-based weather-resistant segments into warmer and more aesthetically pleasing spots. Plasterboards are an ideal tool for achieving this.

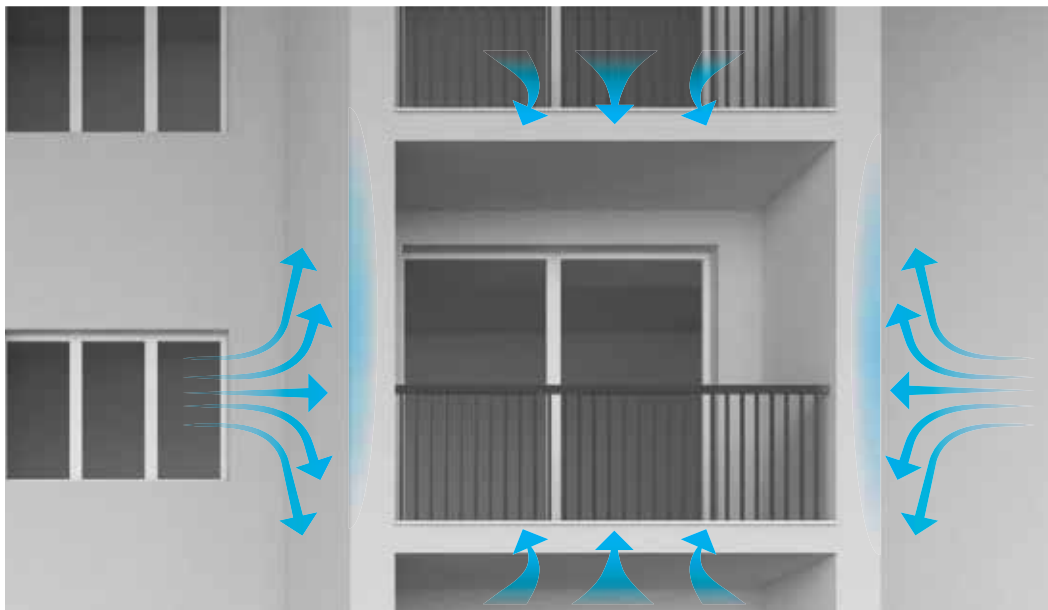

## Determined to turn the loggia into a room?

Have this in mind in advance:

- > It's a multitask operation that will involve investment in glazing, insulation, and decorating materials. In most cases also dismantling the outer wall.
- > If the loggias above and below are not already integrated into a room, your is exposed to the outside weather conditions, such as wind, from all 4 sides. Therefore the type of thermal insulation must be carefully selected in consultation with manufacturers.
- > Heating of your room was calculated based on the original surface. By adding the surface of loggia the heating space will be increased for one very in that term demanding part. Therefore consider also upgrading the heating capacities.



# How to integrate a LOGGIA into a room

Work in progress

Integrated loggia as a small office:

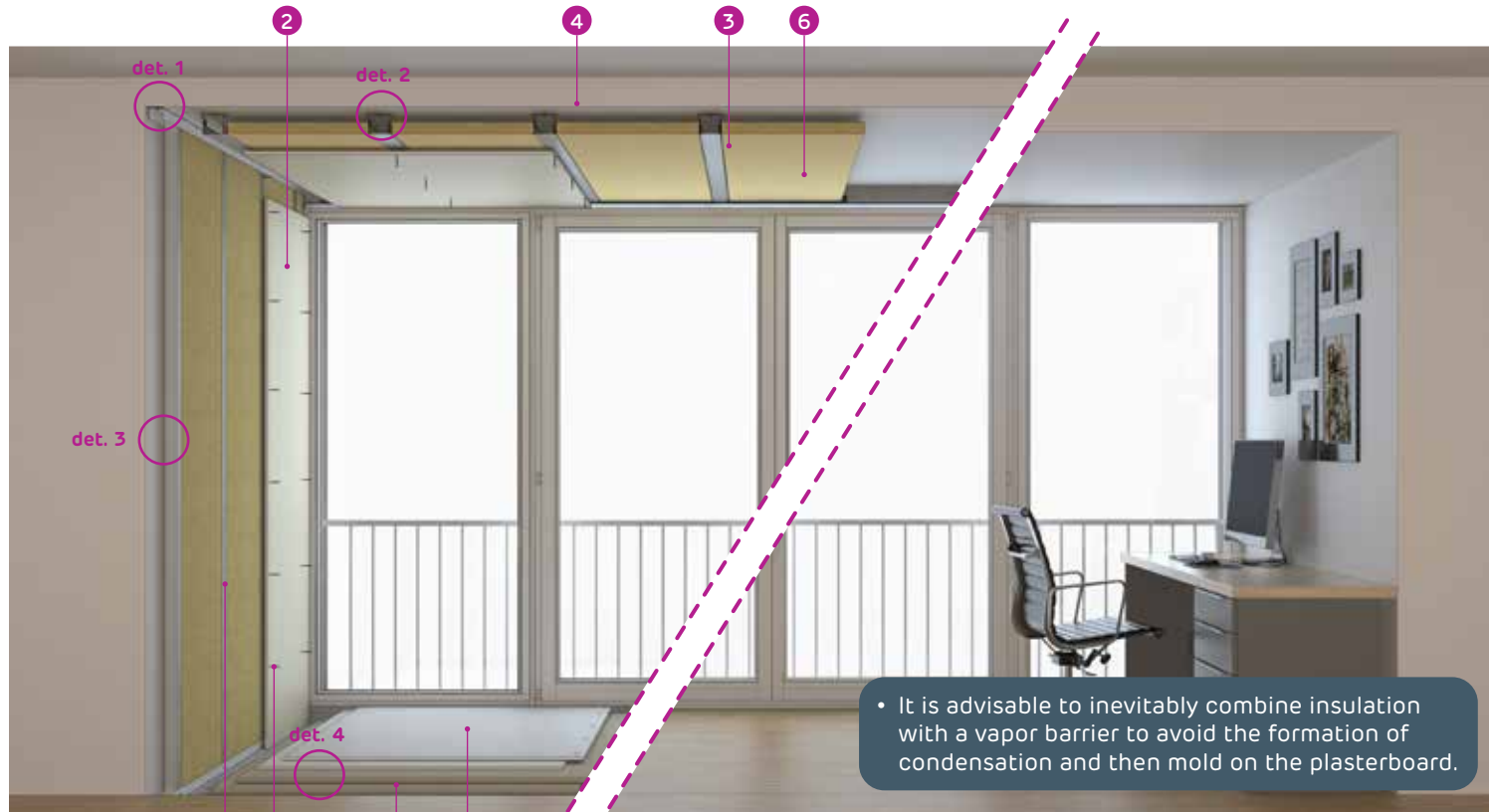

• It is advisable to inevitably combine insulation with a vapor barrier to avoid the formation of condensation and then mold on the plasterboard.

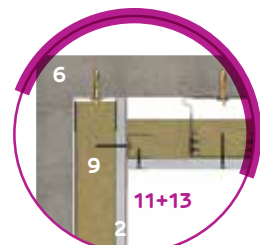

det. 1

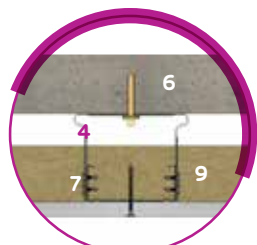

det. 2

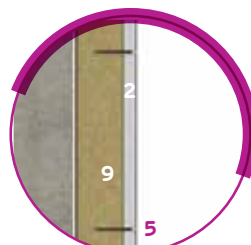



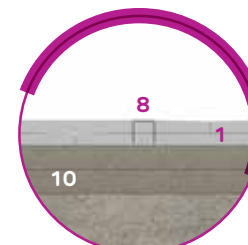



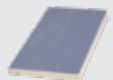

det. 3

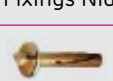
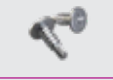
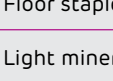
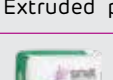

det. 4

## Components

- 1  **LaDura 12.5 mm Plasterboards**
- 2  **Nida Acoustic 12.5mm Plasterboards**
- 3  **Nida Metal profiles CD, UD, CW 50 and UW 50**
- 4  **Adjustable bracket**
- 5  **Fixings Nida Metal AF screws**
- 6  **Metal dowels 6x40**
- 7  **Flat Head screw**
- 8  **Floor staples**
- 9  **Light mineral wool + vapor barrier**
- 10  **Extruded polystyrene - XPS**
- 11  **Jointing compound NIDA Professional**
- 12  **Jointing tape Connect**
- 13  **Corner protection tape Comfort**
- 14  **Hydrosafe® high-performance vapor retarder**

# How to add CURVES to walls and ceilings



While straight walls deliver clean lines that are easy to work with, curved walls offer something rather different. They may not be as common, but walls that curve and bend automatically bring a sense of flow and energy to a room. Sometimes, the curves are built into the architecture of the building and must be cleverly incorporated into the room scheme. Often, though, a curved wall can be added to act as a foil to strong, vertical, and horizontal lines, or as a partition or zoning device, softly dividing a space without looking obtrusive. Smooth, curving lines can improve functionality and boost good feeling, both inside and out, so take inspiration from these inspiring spaces, which have curves in all the right places. Sometimes, it's the architecture of the building that curves. If you live in a home with soft rather than straight lines, work with them. Long, bold horizontal shapes draw attention to the curving wall in this apartment and lead the eye around the space.

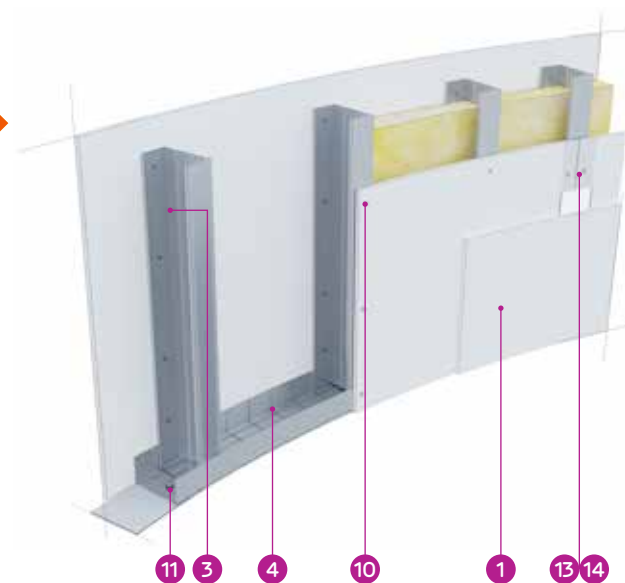
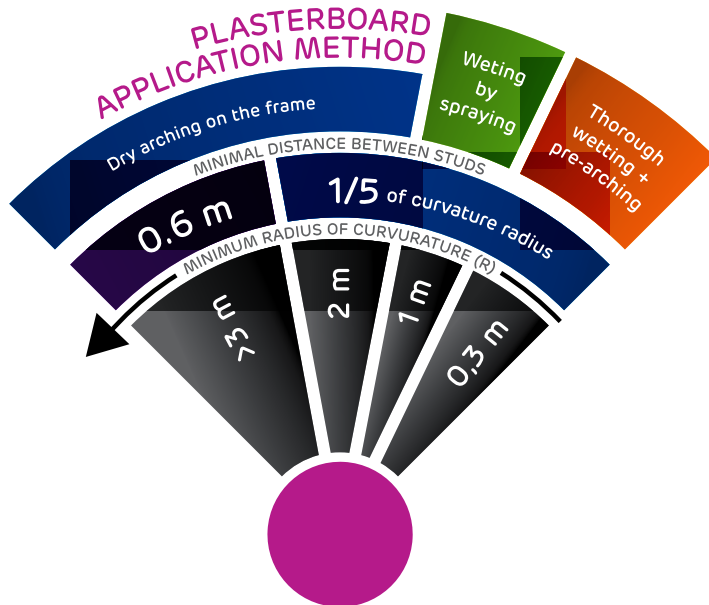

## Why curved surfaces in interiors?

Specific advantages of the curved surfaces in interiors:

- > Ability to create a variety of non-standard shapes.
- > Contoured surfaces can take away a feeling of severity or stiffness in your home environment.
- > Interiors with curved shapes bring a sense of naturalness as many elements in nature have rounded edges.
- > Curved shapes are considered to bring also a sense of luxury. Apartments with integrated curves have a higher market price.

# How to add CURVES to walls and ceilings



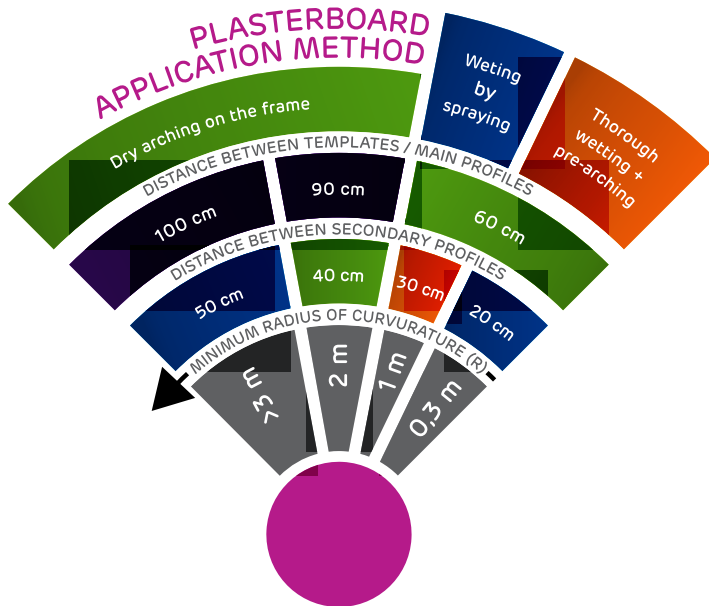

## Curved ceilings

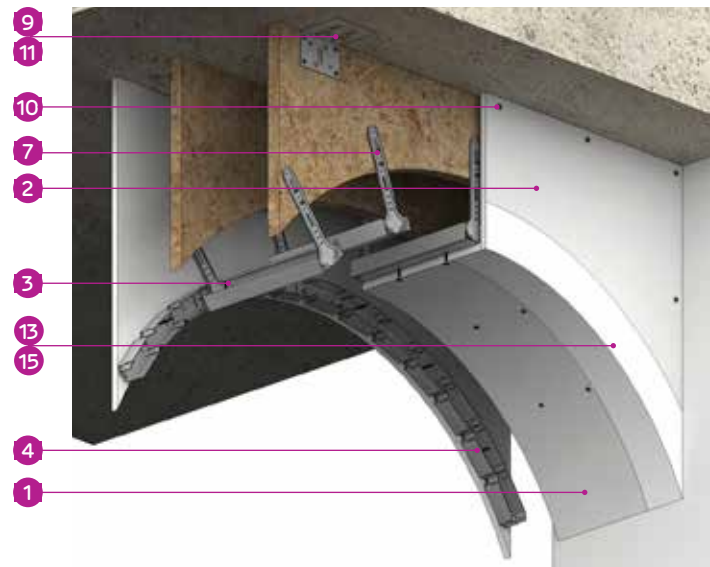

## Arched doorway



## Components

- 1  **Nida FLEX 6,5**  
Plasterboards
- 2  **LaDura 12,5 mm**  
Plasterboards
- 3 **Nida Metal profiles**  
**CD, UD, CW 50 and UW 50**
- 4  **Nida FLEX profiles**  
UW, CD, UD
- 5  **Multiple bracket 9-12**
- 6  **Nonius set**
- 7  **Hanger for wood**
- 8  **Cross connector**
- 9 **Corner for UA 100**
- 10 **Fixings Nida Metal AF screws**
- 11  **Metal dowels 6x40**
- 12  **Flat Head screw**
- 13  **Jointing compound**  
**NIDA Professional**
- 14  **Jointing tape Connect**
- 15  **Perforated PVC profile**  
for arched corners



## Adding NICHES to partition walls of your interiors



Indispensable elements of every home, especially living rooms and children's rooms, are shelves. The use of shelves allows us to use space wisely and fill-in empty walls in any room. Today, thanks to the development of design, there are shelves of incredible shapes, sizes, which are anchored on the wall or placed on the floor. But as the option, there are also niches and there are several reasons why they have the potential to be more useful than the usual shelves. In the first place, practicality stands out, because they save space and increase the visual effect of the room. They form a single whole with the wall. It is possible to make them together with the remaining of plasterboard works, so they would make a monolith segment. Moreover, niches as built-in shelves are usually durable, so you do not have to think about its lifespan. With a combination of adequate plasterboard and different colors, niches exude modernity and tidiness, and the design of an ordinary shelf could rarely replace it.

### Why the niches are equally about practicality and esthetics.

- > Niches allow you to hide the defects of the walls and ceiling space, they create the necessary stylistic accents in the interior, making it more original and exclusive.
- > Owners are provided with a place to store accessories, figurines, and memorable gizmos dear to the heart. Depending on the size of the niches, they perfectly accommodate household appliances and electronics, furniture, and other household items (beds and armchairs, stereos, fireplaces, televisions).
- > In the interior of a niche, you can install shelves of wood or glass, which will house plants, photo frames, and favorite books. Even the whole library will be organized in a separate module.
- > Thanks to the built-in LED backlight, you can use a niche as a night light.

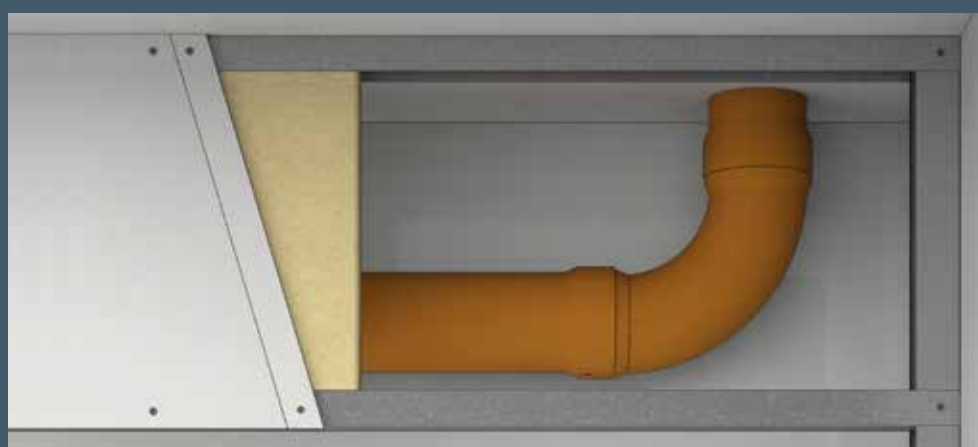

In corners of the rooms, we often meet pipes (water, heating, sewerage...) that distort the interior harmony. We can make several types of masks to hide them, but if the pipe extends over the entire length of the wall, assembling plasterboard wall with integrated niches imposes itself as a logical solution that will combine aesthetics with practicality. In that case, it is recommended to use 2 layers of plasterboards and to fill the cavity behind with mineral wool for the pipe-noise reduction.

## Adding

# NICHES to partition walls of your interior

Work in progress

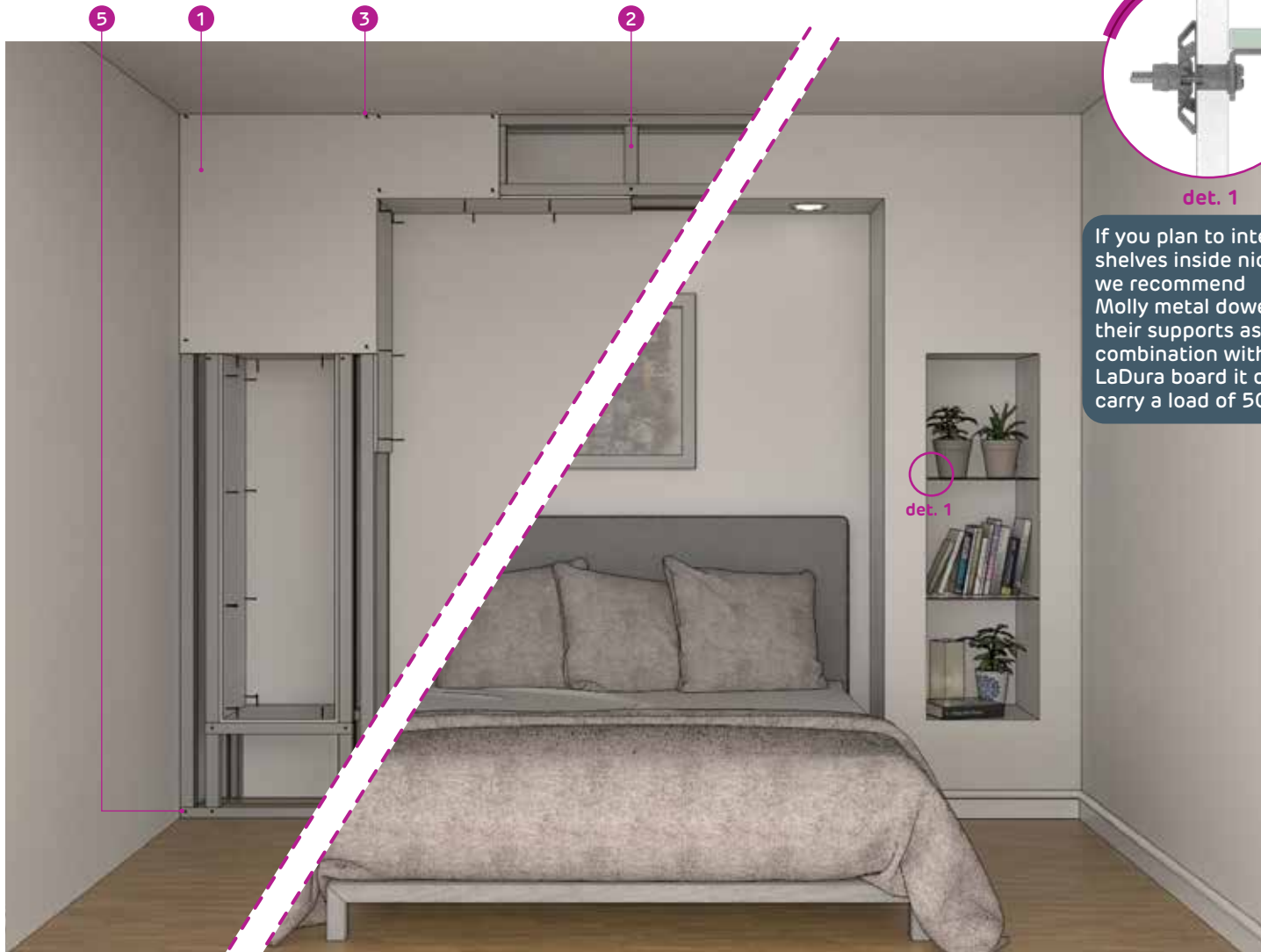

det. 1

If you plan to integrate shelves inside niches, we recommend Molly metal dowel as their supports as in combination with the LaDura board it can carry a load of 50 kg.

det. 1

Final look

## Components

1



LaDura 12,5 mm  
Plasterboards

2



Nida Metal profiles  
CW 50 and UW 50

3



Fixings Nida Metal  
AF screws

4



Metal dowels 6x40

5



Flat Head screw

6



Molly screw

7



Jointing compound  
NIDA Profesional

8



Jointing tape **Connect**

9



Corner protection tape  
**Comfort**

## How to finish internal window SLOPES



It is hard to imagine a modern piece of architecture without practical window openings. The main role of windows is to illuminate the interior naturally. This is lately being very appreciated as the latest research proves that the natural light has a special influence on the psychological state of the indoor inhabitant, as it helps him to have the subconscious feeling of open space around him. Not only the appearance of the opening itself plays an important role, but also the decoration of window slopes inside and out. General problems when replacing windows is that the companies involved in installing windows refuse to be involved in any additional process, leaving the internal slopes in a damaged shape, caused by removing the old window openings. But on the other hand, refurbishing internal slopes is a very simple process that could be managed by homeowners. The most practical solution is the installation of plasterboards because their application results in very flat slope surface by which is avoided potential shading around the window.

## 2 methods for finishing internal window slopes with plasterboard

### With supporting framing

- > Considers a combination of NIDA Metal profiles and accessories.
  - > Provides greater resistance to shocks and pressures
- > Allows the use of insulation to prevent any outdoor temperature influence in the case of improper sealing of the window from the external side.



- > If the construction is placed correctly, the system guarantees an absolute plane of the surfaces as well as precise 90 degrees angles in all 4 corners.
- > Upper horizontal slope can be used to attach and suspend any type of window application, such as light features, blinds, curtains, even the smaller ceramic flower pots.

### Without supporting framing

- > Recommended for the slopes with the shallow damages made by removing old window frames and for the original slopes made after the first window installment (new buildings).
  - > Reduce the range of materials and tools required for installation.
  - > Allows very fast processing of the slopes.





# How to finish internal window SLOPES



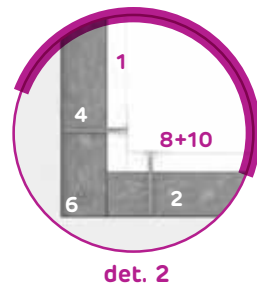
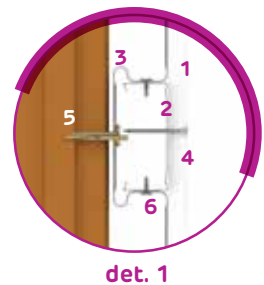
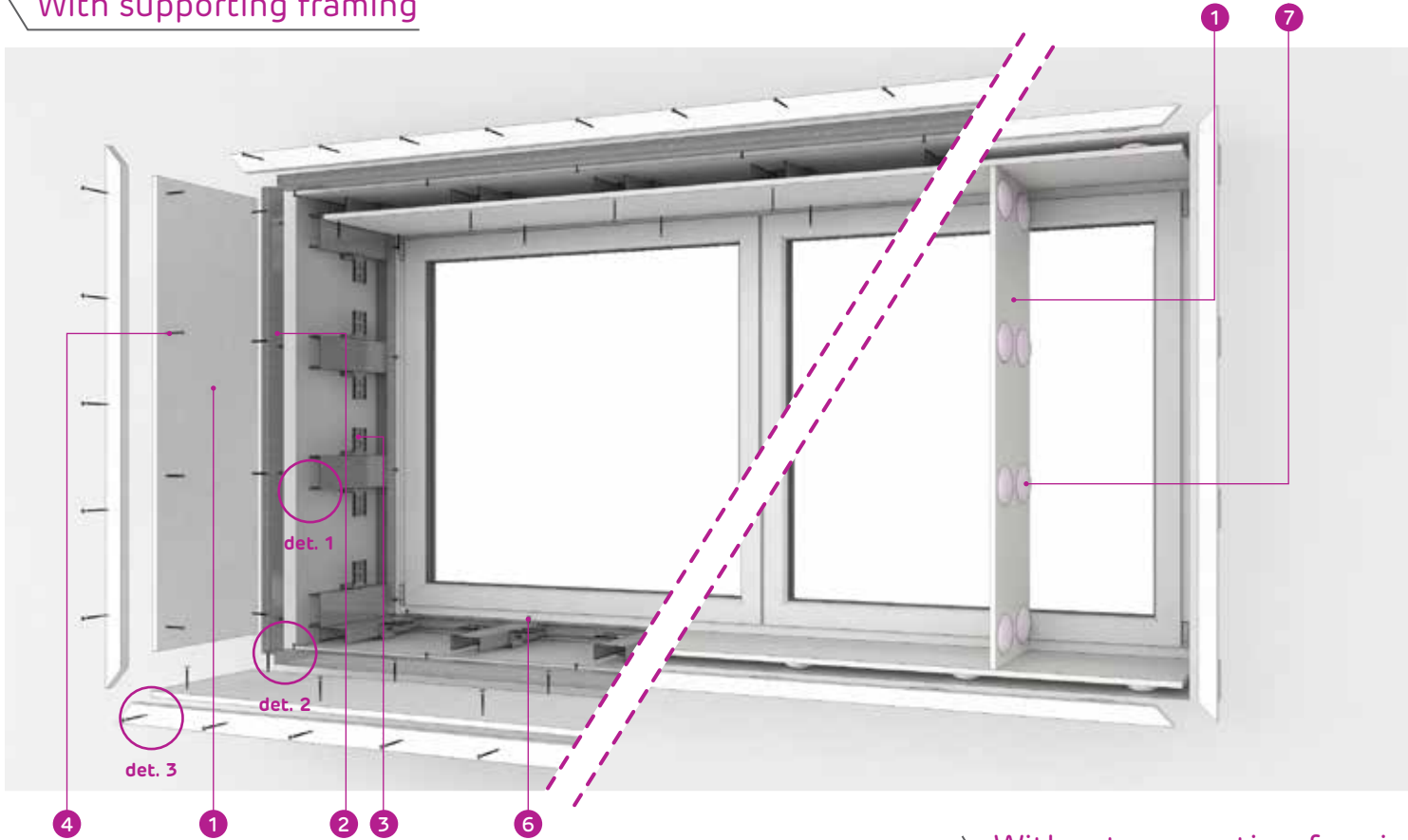



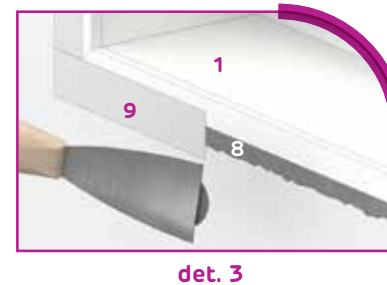

With supporting framing

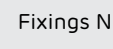

Without supporting framing



## Components

- 1  **LaDura 12,5 mm Plasterboards**
- 2  **Nida Metal profiles CD, UD**
- 3  **Adjustable bracket**
- 4  **Fixings Nida Metal AF screws**
- 5  **Metal dowels 6x40**
- 6  **Flat Head screw**
- 7  **Jointing compound Nida Boardfix**
- 8  **Jointing compound NIDA Profesional**
- 9  **Jointing tape Connect**
- 10  **Corner protection tape Comfort**

## How to assemble plasterboard-based BATHROOM SEGMENTS



Furniture and other vertical surfaces made of plasterboard for the bathroom are a great alternative to the generally accepted and short-lived PVC-based options or expensive finishes made from natural materials. With the new generation of innovative and performing boards, even a bathroom, which is due to high humidity is a very demanding zone, can be subjected to this type of finishing. The basic rule to follow here is to apply an adequately galvanized frame and wet area boards - such as Aquaboard or Cementex. You can design and install cabinets with shelves under the sink and cabinets for bathroom accessories. The manufacture of bathroom furniture uses the standard principle of assembly of the frame with the steps of trimming and finishing. And finally, as bathrooms represent a special corner for practicing aesthetics, it's good to know that both Cementex and Aquaboard present a perfect basis for applying ceramic tiles.

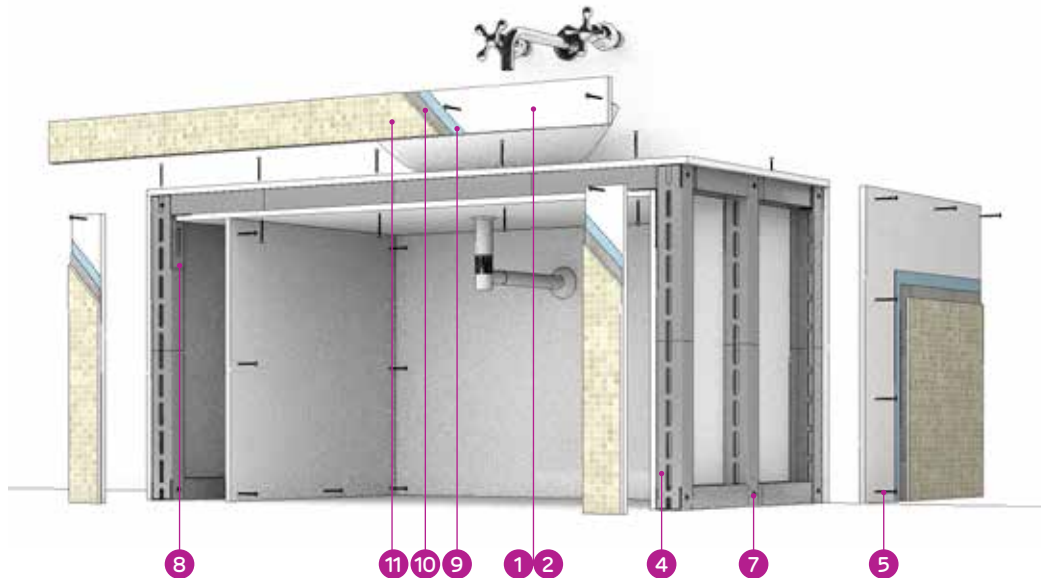

### Good to know in advance

- > Both **Cementex** and **Aquaboard** are water resistant, yet we strongly suggest their surface treatment with the flexible waterproofing compound.
- > As the sink loaded with water can represent a serious load, especially if the sink is not suspended on the wall. This is why we recommend the usage of a supporting structure made of UA profiles of 2mm thickness.
  - > Supporting structure and fixings should be in C3 class (additional anti-moisture treatment)
  - > Space below the horizontal surface can be used for movable shelves, but we don't recommend their fixing for the surfaces of the **Aquaboard** & **Cementex**.

# How to assemble plasterboard-based BATHROOM SEGMENTS

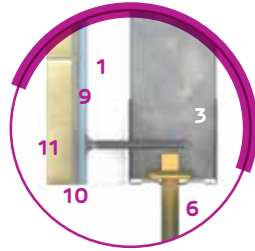

det. 1

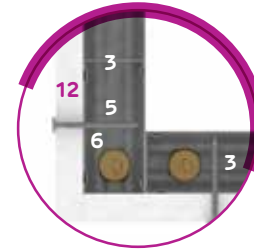

det. 2

Plasterboard & cementboard-based bathtub linings are set to increase the aesthetic value of the bathroom. They are not load-bearing elements and before their installation, it must be ensured that the full load of the bathtub is transmitted to its supports, never to the linings.

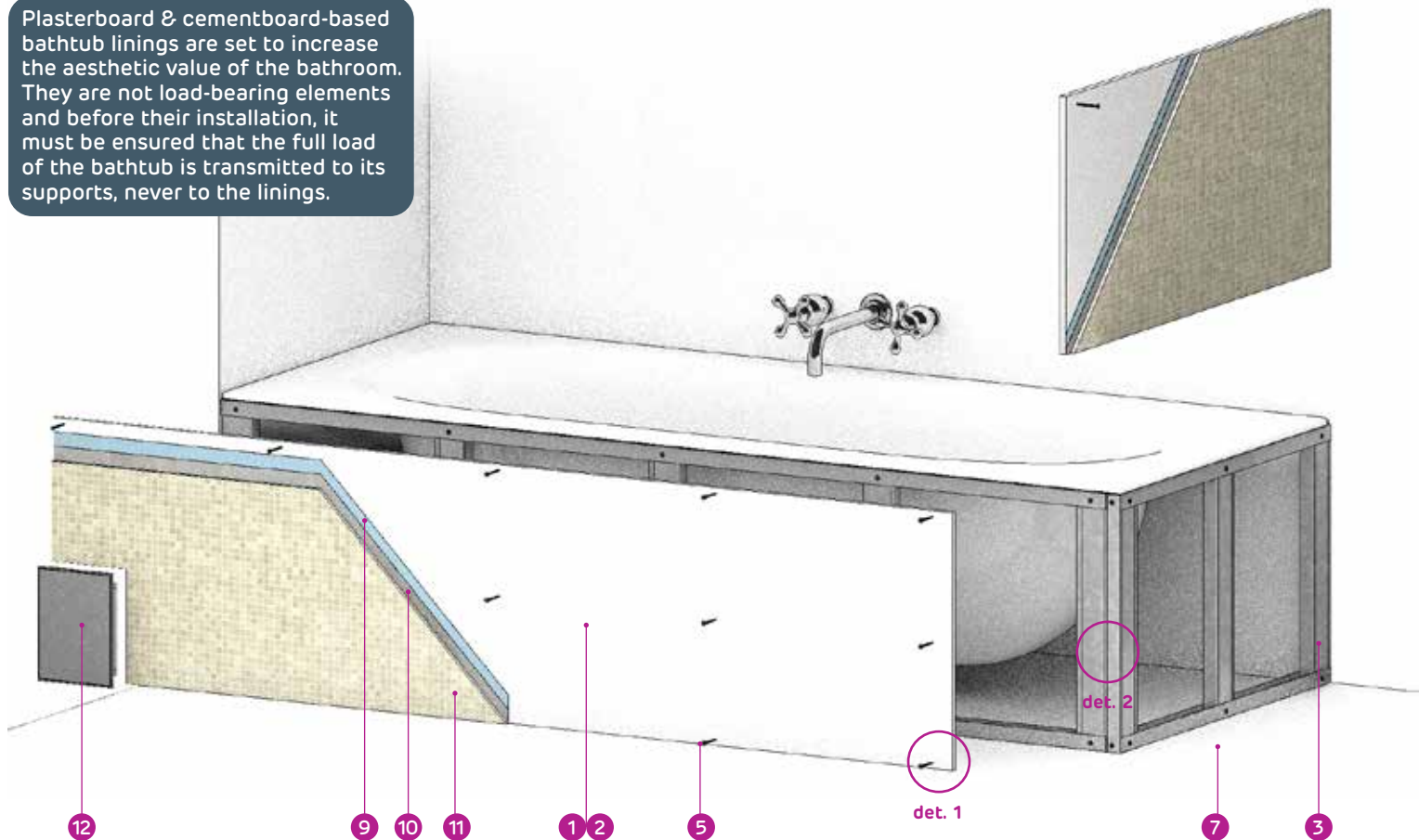

## Components

- 1  **Aquaboard 12.5mm**  
Plasterboard

---

- 2  **Cementex 12mm**  
Plasterboards

---

- 3  **Nida Metal ZN275**  
profiles **CD and UD**

---

- 4  **Nida Metal ZN275**  
profiles **50/75/100**

---

- 5  **Nida Metal ZN275**  
**AF screws**

---

- 6  **Metal dowels 6x40**

---

- 7  **Flat Head screw**

---

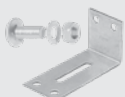
- 8  **Angle for UA profiles**  
**C3 and M8 screw**  
with washer

---

- 9 **Primer + flexible**  
waterproofing layer

---

- 10 **Super flexible adhesive**  
for ceramic tiles

---

- 11 **Ceramic lining with putty** for joints

---

- 12 **Galvanised access panel**



## How to build A GABLE WALL below a roof slopes



The gable wall is in practice the most common solution for one or more sides of the roof on houses. Generally, is the A-shaped section of the wall between two intersecting sloping sides, which can be the same size or different sizes depending on your property. Many people are in favor of a roof design with the included gable wall because of its simple and sturdy structure. It's built with fewer materials and it isn't complex in design compared to other roofs. Additionally, it's the least expensive type of roof to construct that provides the most optimized usage of the attic. With new technologies and materials of the new generation that are resistant to weather conditions, the range of usable products has increased. Cementex boards due to the easy way of installation but also compatibility with a wide range of aesthetic paints and facade finishes have taken precedence with gable walls for low-rise individual residential buildings.



### What are the main benefits of gable roofing:

- > **Low cost** - the overall costs of building and installing gable roofs are significantly lower than more complex roofing alternatives, as they are simple to design and cheaper to build/install.
- > **Water drainage.** The sloped design of a gable roof allows for exceptional water drainage, as the way the pitch is angled means rain and snow can slide off the roof easily. This will cause fewer leaks as it eliminates any build-up of water, which, in turn, will ensure your roof remains fully functional for longer.
- > **Additional space** - compared with alternative roofing designs, the pitched shape of gable roofs means they offer the most space for an attic or vaulted ceilings. Not only that, the additional space also helps to improve ventilation within the property.

# How to build A GABLE WALL below a roof slopes

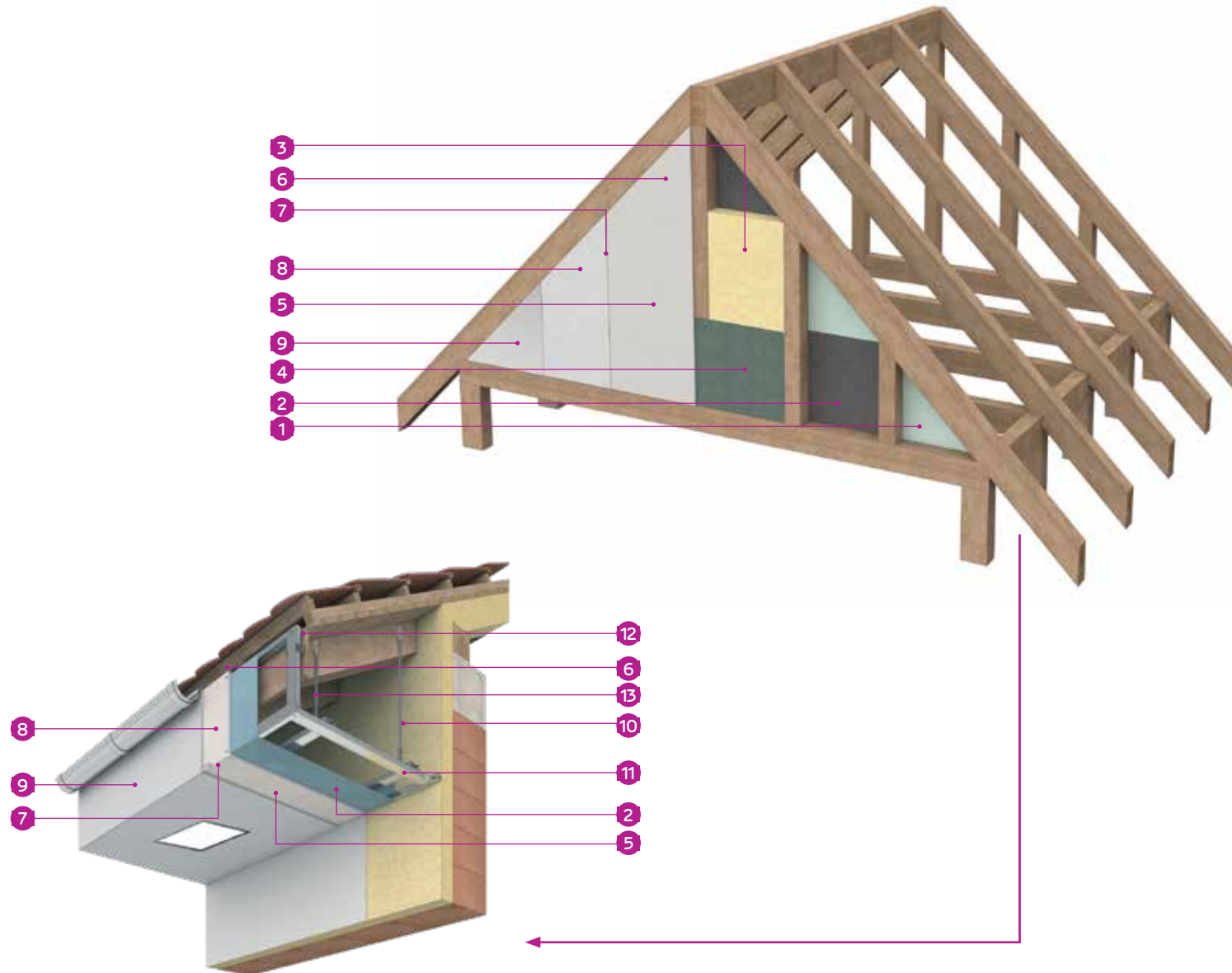

## Components

- 1  **Nida**  
Plasterboards
- 2  **Hydrosafe®**  
high-performance vapor  
retarder
- 3  Mineral Wool
- 4  Anti-condensation foil
- 5  **Cementex Fibercement**  
Plasterboard
- 6  **Hydropanel screws**  
for Cementex
- 7  **Wood screws**  
for Nida Boards
- 8  Jointing treatment:  
cement base
- 9  **Adera**  
**Betoprimer**
- 10  Exterior render
- 11  **Nonius set**
- 12  **Nida Metal profiles**  
**CD and UD**
- 13  Adjustable bracket
- 14  **Flat Head** screw

## Treatment of joints

# WITH FIRE RESISTANCE REQUIREMENTS

In the case of fire-resistant positions, the joints between the plasteboards are treated with NIDA Profesional joint plaster or NIDA Profesional Fresh, applied in successive layers in combination with the fiberglass joint tape.

Cover the ends of the screws with two or three layers of compound, letting the plaster dry before applying the following layer. The outer corners are protected with metal profiles or reinforced aluminum tape.

Micro-perforated fiberglass tape fixed with plaster will be applied on the interior angles.

After the treatment of the joints, the finishing of the visible surface will be done by applying the finishing plaster, primer&paint or a wallpaper.



### Jointing and finishing QUALITY LEVELS

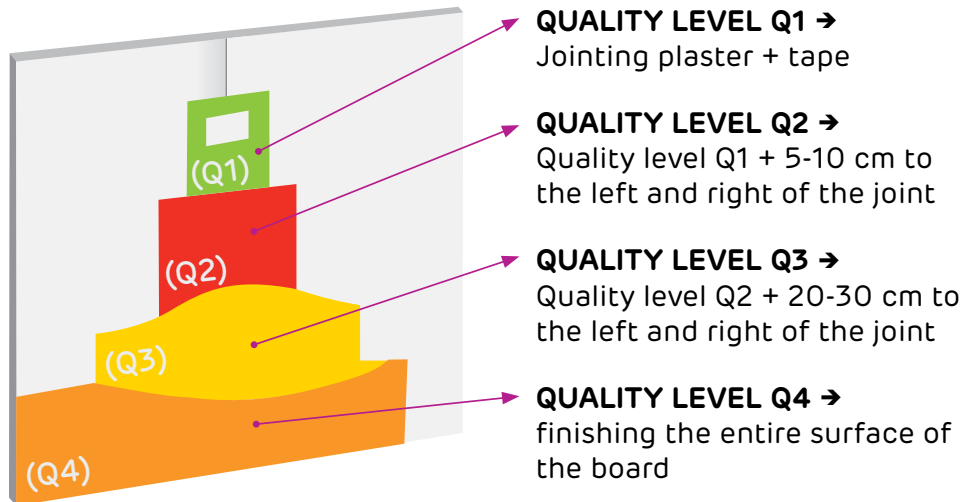

### Treating the joints WITH FIRE RESISTANCE REQUIREMENTS



✓ \* Fire resistance projects

**NIDA Profesional**  
✓ Joints leveling and finishing



**ADERA Liss**  
✓ Finishing skimming

or



**NIDA Readymix Profesional**  
✓ Readymix skimming

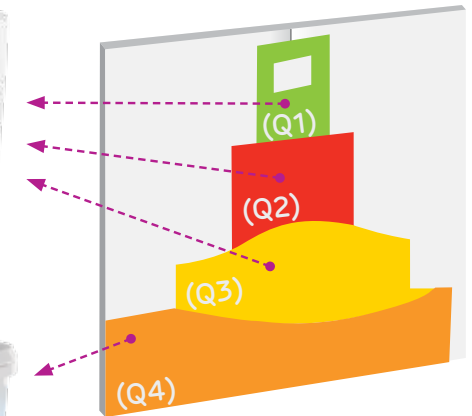



## Treatment of joints with high aestetical demands WITHOUT FIRE RESISTANCE REQUIREMENTS

### Jointing with a tape "Connect"

The **Connect joining tapes** are used for plasterboard joints on straight surfaces (ceiling or wall) instead of mesh tape, fiberglass or a paper tape. The innovative core tape formula offers a strong, crack-resistant bond. High quality materials make it the perfect solution for wet environments, where paper tape is not recommended.

The **Connect tape** does not require moistening before use. Instructions for use can be found on the product data-sheet.

### Treating the joints of the ceilings WITHOUT FIRE RESISTANCE REQUIREMENTS

#### NIDA Profesional

- ✓ Joints leveling and finishing



or



#### Smart Top

- ✓ Joint filler for plasterboards jointing and finishing

#### ADERA Liss

- ✓ Finishing skimming



or



#### NIDA Readymix Profesional

- ✓ Readymix skimming

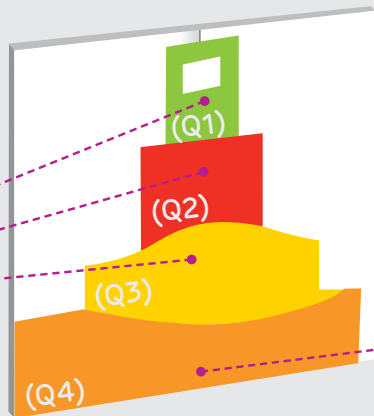

### Jointing with a paper tape

- The application is done manually with a 30 cm trowel and a 15 cm spatula
- Special attention will be paid to high temperatures and strong ventilated areas
- The application is done through the following steps:
  1. Apply the first layer of the compound (Smart Top / Nida Profesional / Nida Profesional Fresh) so that the paste is pressed very well into the joint;
  2. Then trace with the spatula on the joint between the boards to allow the paste to penetrate inside it and prevent any air gaps. Thus, it prevents the "suction" of the paste inside the joint, after curing and drying.
  3. Apply the Connect tape, the pre-moistened paper tape, or the fiberglass tape directly to the spatter joint paste by pressing with the spatula; this will remove the air intakes and paste excess from the joint;
  4. After drying, apply the second layer of jointing plaster Smart Top / Nida Profesional / Nida Profesional Fresh, covering the tape and flatness differences.
  5. Remove any surplus material;
  6. After the second layer has dried, apply the finishing coat;
  7. For exceptional finishing, as a last layer, it is recommended to use the Adera Liss finishing skimming or Nida Readymix Profesional.

### Covering the screws

- Apply two or three coats on the screw heads, while letting the plaster dry after each layer.

## Treatment of joints with high aestetical demands

# WITHOUT FIRE RESISTANCE REQUIREMENTS

### Treatment of external corners

- This operation is done with the ultra-modern Comfort Corner tape for inner and outer corner of plasterboard.
- The Comfort tape is the ideal solution for joining plasterboards in different angles. The optimized folding line shape combined with high tape flexibility ensures easy fit for a variety of applications for corners of sharp, obtuse and right angles.
- Sides of Comfort tape are used to form and reinforce interior and exterior corners instead, as the alternative to the aluminum corner profiles. With the help of the tape, smooth, straight and resistant corners are obtained. It can be applied at any angle of the interior and exterior corners or at the joint with the ceiling. The innovative formula makes Comfort tape the perfect solution for humid environments, where the project performance of the paper tape does not come to the fore.
- Alternative products for to treat the outer corners are: Alu tape for external corners non-exposed to damages or aluminum right-angled corner profiles
- Apply a layer of Smart Top / Nida Profesional / Nida Profesional Fresh jointing plaster on each side of the corner.
- Fold the edge of the tape along the pointed axis, fixing it on the corner so that the two internal blades will be bonded to the corner boards.
- Remove any surplus material
- Let it dry
- Cover both sides of the corner with Smart Top / Nida Profesional / Nida Profesional Fresh jointing plaster
- Apply a layer of skimming plaster as a surface finish.

### Application of the perforated Aluminum corner profiles

- Apply a layer of Smart Top / Nida Profesional / Nida Profesional Fresh plaster on each side of the corner
- Fix the metal bracket
- Cover both sides with plaster, remove excess and allow to dry
- Remove any plaster remnants and apply a layer of plaster as a surface finishes.

### Another method for the treatment of internal angles is the use of a microfibre paper tape, as follows:

- Apply a layer of Smart Top / Nida Profesional / Nida Profesional Fresh jointing plaster on each side of the corner
- Fold the microfibre tape along the pointed axis and fasten it with the spatula
- Finish with the plaster on one side first, letting it dry, then proceed to the other.

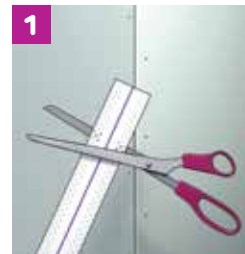

1 Cut the tape to the required length



2 Fold the tape along the perforation at 90° or at another°, as the case may be

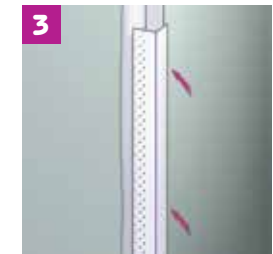

3 Apply a thin layer of jointing plaster and attach the tape to the corner



4 To remove excess compound and air bubbles, use a spatula



5 Apply a thin layer of jointing plaster to the top of the tape and wait until it is completely dry, sand the dry surface using a sandpaper with min. 200



# ADERA Liss

Finishing skimming with  
manual or mechanical  
application



## Benefits:

- ✓ very easy to apply; particularly fine surfaces are obtained
- ✓ ideal for exceptional finishing of plasterboards, leveling skimming and gypsum plasters
- ✓ excellent sanding even after a while longer than application





**Etex Building Performance S.A.**

Str. Vulturilor nr. 98, et. 5-6

sector 3, București

Tel.: (+4) 031 224 01 00

Fax: (+4) 031 224 01 01

[www.siniat.ro](http://www.siniat.ro)

[siniat.ro@etexgroup.com](mailto:siniat.ro@etexgroup.com)

Version: September 2021